

1000-3000 C-SERIES (網格天花系列)

	PART CODE : C-101 (配件編號) PART NAME : Cell Ceiling Support 配件名稱 : 網格吊掛件
	PART CODE : C-102 (配件編號) PART NAME : Z-shape Carrier 配件名稱 : 網格加力根
	PART CODE : C-103 (配件編號) PART NAME : Hanger Bracket 配件名稱 : 網格龍骨吊碼
	PART CODE : C-104 (配件編號) PART NAME : Security Clip 配件名稱 : 網格防風碼
	PART CODE : C-105 (配件編號) PART NAME : Z-profile Clamp 配件名稱 : 十字吊碼
	PART CODE : C-106 (配件編號) PART NAME : C-Channel Bracket 配件名稱 : C型龍骨駁碼
	PART CODE : C-107 (配件編號) PART NAME : Runner Connector 配件名稱 : 網格龍骨駁碼
	PART CODE : C-162 (配件編號) PART NAME : C-Channel 配件名稱 : C型龍骨
	PART CODE : CLT (配件編號) PART NAME : Light Adapter 配件名稱 : 燈盒



4000 CS-SERIES (燈片網格天花系列)

	PART CODE : T-2424 (配件編號) PART NAME : T-Cross Runner 配件名稱 : T型副龍骨
	PART CODE : T-2438 (配件編號) PART NAME : T-Main Runner 配件名稱 : T型主龍骨
	PART CODE : P-102 (配件編號) PART NAME : T-Runner Clamp 配件名稱 : T型龍骨吊碼
	PART CODE : CLT (配件編號) PART NAME : Light Adapter 配件名稱 : 燈盒





101 S-SERIES (暗架天花系列)

	PART CODE : S-101 (配件編號) PART NAME : Spring Tee Runner 配件名稱 : 三角龍骨
	PART CODE : S-102 (配件編號) PART NAME : Runner Clamp 配件名稱 : 三角龍骨吊碼
	PART CODE : S-103 (配件編號) PART NAME : Runner Connector 配件名稱 : 三角龍骨駁碼
	PART CODE : S-104 (配件編號) PART NAME : C-Channel Bracket 配件名稱 : C型龍骨吊碼
	PART CODE : S-105 (配件編號) PART NAME : Runner Wall Bracket 配件名稱 : 三角龍骨牆身碼
	PART CODE : S-106 (配件編號) PART NAME : Windproof Channel 配件名稱 : 防風C型龍骨
	PART CODE : S-162 (配件編號) PART NAME : C-Channel 配件名稱 : C型龍骨

102 S-SERIES (暗架天花系列)

	PART CODE : S-201 (配件編號) PART NAME : A-shape Runner 配件名稱 : A字龍骨
	PART CODE : S-202 (配件編號) PART NAME : 1st Runner Clamp 配件名稱 : 第一層A字龍骨吊碼
	PART CODE : S-202A (配件編號) PART NAME : 1st Runner Clamp 配件名稱 : 第一層A字龍骨吊碼
	PART CODE : S-203 (配件編號) PART NAME : Runner Connector 配件名稱 : A字龍骨駁碼
	PART CODE : S-204 (配件編號) PART NAME : 2st Runner Clamp 配件名稱 : 第二層A字龍骨吊碼
	PART CODE : S-205 (配件編號) PART NAME : Runner Wall Bracket 配件名稱 : A字龍骨牆身碼

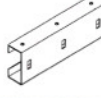

103 S-SERIES (暗架天花系列)

	PART CODE : S-301 (配件編號) PART NAME : O-shape Runner 配件名稱 : 球型龍骨
	PART CODE : S-302 (配件編號) PART NAME : Runner Clamp 配件名稱 : 球型龍骨吊碼
	PART CODE : S-303 (配件編號) PART NAME : Runner Connector 配件名稱 : 球型龍骨駁碼
	PART CODE : S-304 (配件編號) PART NAME : Carrier Bracket 配件名稱 : 定位C型龍骨吊碼
	PART CODE : S-305 (配件編號) PART NAME : Carrier Wall Bracket 配件名稱 : 定位C型龍骨牆身碼
	PART CODE : S-306 (配件編號) PART NAME : Positioned Carrier 配件名稱 : 定位C型龍骨

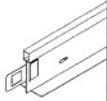
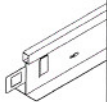
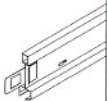
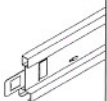

BR-SERIES (條型天花系列)

	PART CODE : BR-101 (配件編號) PART NAME : BR Runner 配件名稱 : BR龍骨
	PART CODE : BR-102 (配件編號) PART NAME : BR Runner Clamp 配件名稱 : BR龍骨吊碼
	PART CODE : BR-103 (配件編號) PART NAME : BR Runner Connector 配件名稱 : BR龍骨吊碼
	PART CODE : BR-104 (配件編號) PART NAME : C-Channel Bracket 配件名稱 : C型龍骨吊碼
	PART CODE : BR-105 (配件編號) PART NAME : Runner Wall Bracket 配件名稱 : BR龍骨牆身碼
	PART CODE : BR-162 (配件編號) PART NAME : C-Channel 配件名稱 : C型龍骨

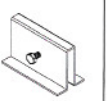

201-203 P-SERIES (明架天花系列)

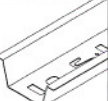
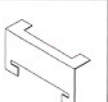
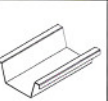
	PART CODE : T-2424 (配件編號) PART NAME : Cross T-Runner 配件名稱 : T型副龍骨
	PART CODE : T-2438 (配件編號) PART NAME : Main T-Runner 配件名稱 : T型主龍骨
	PART CODE : T-2424U (配件編號) PART NAME : Recessed Cross T-Runner 配件名稱 : 凹陷T型副龍骨
	PART CODE : T-2438U (配件編號) PART NAME : Recessed Main T-Runner 配件名稱 : 凹陷T型主龍骨
	PART CODE : P-102 (配件編號) PART NAME : T-Runner Clamp 配件名稱 : T型龍骨吊碼
	PART CODE : P-103 (配件編號) PART NAME : Security Clip 配件名稱 : 防風碼

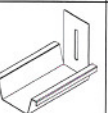
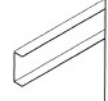

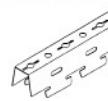

L-SERIES (有縫條型天花系列)

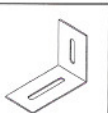
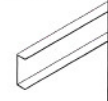
	PART CODE : L-101 (配件編號) PART NAME : U-shape Runner 配件名稱 : U型龍骨
	PART CODE : L-102 (配件編號) PART NAME : Runner Clamp 配件名稱 : U型龍骨吊碼
	PART CODE : L-103 (配件編號) PART NAME : Runner Connector 配件名稱 : U型龍骨駁碼
	PART CODE : L-104 (配件編號) PART NAME : C-Channel Bracket 配件名稱 : C型龍骨吊碼
	PART CODE : L-105 (配件編號) PART NAME : Runner Wall Bracket 配件名稱 : U型龍骨牆身碼
	PART CODE : L-162 (配件編號) PART NAME : C-Channel 配件名稱 : C型龍骨

D-SERIES (有縫條型天花系列)

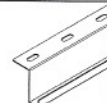

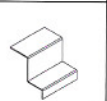
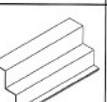
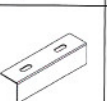
	PART CODE : D-101 (配件編號) PART NAME : D-shape Runner 配件名稱 : D型龍骨
	PART CODE : D-102 (配件編號) PART NAME : Runner Clamp 配件名稱 : D型龍骨吊碼
	PART CODE : D-103 (配件編號) PART NAME : Runner Connector 配件名稱 : D型龍骨駁碼
	PART CODE : D-104 (配件編號) PART NAME : C-Channel Bracket 配件名稱 : C型龍骨吊碼
	PART CODE : D-105 (配件編號) PART NAME : Runner Wall Bracket 配件名稱 : D型龍骨牆身碼
	PART CODE : D-162 (配件編號) PART NAME : C-Channel 配件名稱 : C型龍骨

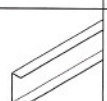
HO-SERIES (勾疊天花系列)

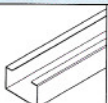
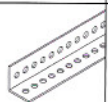
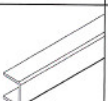
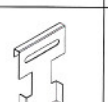
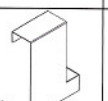
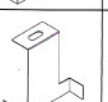
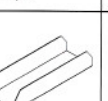

	PART CODE : HO-101 (配件編號) PART NAME : Z-shape Runner 配件名稱 : Z型龍骨
	PART CODE : HO-102 (配件編號) PART NAME : Z-profile Clamp 配件名稱 : 十字吊碼
	PART CODE : HO-103 (配件編號) PART NAME : Security Clip 配件名稱 : 標準防風碼
	PART CODE : HO-103A (配件編號) PART NAME : Security Clip with Black gasket 配件名稱 : 防風碼配黑膠條
	PART CODE : HO-104 (配件編號) PART NAME : Runner Connector 配件名稱 : Z型龍骨駁碼
	PART CODE : HO-105 (配件編號) PART NAME : Runner Wall Bracket 配件名稱 : Z型龍骨牆身碼
	PART CODE : HO-162 (配件編號) PART NAME : C-Channel 配件名稱 : C型龍骨

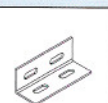
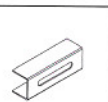
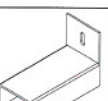
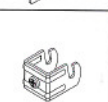
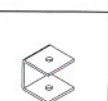
WG-SERIES (闊骨天花系列)

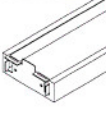

	PART CODE : WG-CR (配件編號) PART NAME : WG Main Runner 配件名稱 : WG主龍骨
	PART CODE : WG-101 (配件編號) PART NAME : Perforated L-angle 配件名稱 : 有孔L型副龍骨
	PART CODE : WG-101A (配件編號) PART NAME : U-Channel 配件名稱 : U型副龍骨
	PART CODE : WG-102 (配件編號) PART NAME : WG Runner Clamp 配件名稱 : WG主龍骨吊碼
	PART CODE : WG-102A (配件編號) PART NAME : Hanger Bracket A 配件名稱 : 衣架碼-A
	PART CODE : WG-102B (配件編號) PART NAME : Hanger Bracket B 配件名稱 : 衣架碼-B
	PART CODE : WG-103 (配件編號) PART NAME : Main Runner 配件名稱 : 主龍骨駁碼

	PART CODE : WG-104 (配件編號) PART NAME : Perforated L-angle Connector 配件名稱 : L型副龍骨駁碼
	PART CODE : WG-104A (配件編號) PART NAME : U-Channel Connector 配件名稱 : U型副龍骨駁碼
	PART CODE : WG-105 (配件編號) PART NAME : Main Runner Wall Bracket 配件名稱 : 主龍骨牆身碼
	PART CODE : WG-106 (配件編號) PART NAME : Cross U-Channel Bracket 配件名稱 : U型副龍骨吊碼
	PART CODE : WG-107 (配件編號) PART NAME : Ceiling Bracket 配件名稱 : 樓底碼
	PART CODE : WG-108 (配件編號) PART NAME : Screw rod with nuts 配件名稱 : 螺絲杆配絲姆

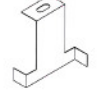

TG-SERIES (泰坦天花系列)

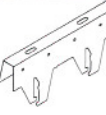
	PART CODE : TG-CR (配件編號) PART NAME : Tartan Grid Runner 配件名稱 : 泰坦龍骨
	PART CODE : TG-BX (配件編號) PART NAME : Tartan Crossing Box 配件名稱 : 泰坦方盒
	PART CODE : TG-HB (配件編號) PART NAME : Hanger Bracket 配件名稱 : 泰坦衣架碼

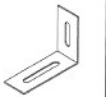

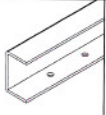

UV-SERIES (垂直片型掛式天花系列)

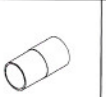
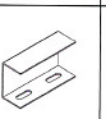
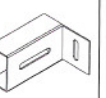
	PART CODE : UV-101 (配件編號) PART NAME : UV Runner 配件名稱 : UV龍骨
	PART CODE : UV-102 (配件編號) PART NAME : Runner Connector 配件名稱 : UV龍骨駁碼
	PART CODE : UV-103 (配件編號) PART NAME : Runner Connector Bracket 配件名稱 : UV龍骨牆身碼

UT-SERIES (圓筒條型天花系列)

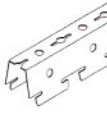
	PART CODE : UT-101 (配件編號) PART NAME : Perforated Carrier 配件名稱 : 有孔C型龍骨
	PART CODE : UT-102 (配件編號) PART NAME : Bolts, Nuts & Rings 配件名稱 : 螺絲、絲姆及介子
	PART CODE : UT-301/UT-501 (配件編號) PART NAME : End Cap 配件名稱 : 封口蓋
	PART CODE : UT-302/UT-502 (配件編號) PART NAME : Tube Connector 配件名稱 : 圓筒天花駁碼
	PART CODE : UT-103 (配件編號) PART NAME : Carrier Connector 配件名稱 : 龍骨駁碼
	PART CODE : UT-104 (配件編號) PART NAME : Carrier Wall Bracket 配件名稱 : 龍骨牆身碼

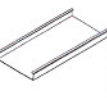
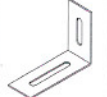

US-SERIES (間縫條型天花系列)



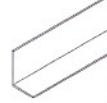
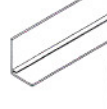
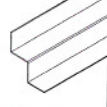
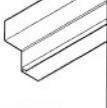
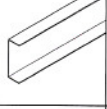
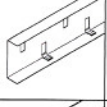
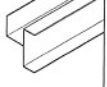

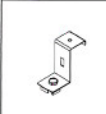
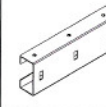

	PART CODE : US-101 (配件編號) PART NAME : US Runner 配件名稱 : US龍骨
	PART CODE : US-102 (配件編號) PART NAME : US Runner Clamp 配件名稱 : US龍骨吊碼
	PART CODE : US-103 (配件編號) PART NAME : US Runner Connector 配件名稱 : US龍骨駁碼
	PART CODE : US-104 (配件編號) PART NAME : C-Channel Bracket 配件名稱 : C型龍骨吊碼
	PART CODE : US-105 (配件編號) PART NAME : Panel Connector 配件名稱 : 天花片駁碼
	PART CODE : US-106 (配件編號) PART NAME : Runner Wall Bracket 配件名稱 : US龍骨牆身碼

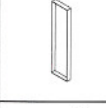
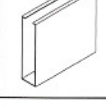
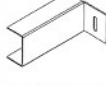
WALL ANGLE (牆身角)

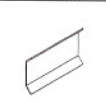
	PART CODE : L-40/L-50 (配件編號) PART NAME : L-angle 配件名稱 : L角
	PART CODE : L-50A (配件編號) PART NAME : Windproof L-angle 配件名稱 : 防風L角
	PART CODE : W-80 (配件編號) PART NAME : W-angle 配件名稱 : W角
	PART CODE : W-80A (配件編號) PART NAME : Windproof W-angle 配件名稱 : 防風W角
	PART CODE : C-62 (配件編號) PART NAME : C-Channel 配件名稱 : C槽
	PART CODE : S-104 (配件編號) PART NAME : C-Channel with spring clip 配件名稱 : 防風C槽
	PART CODE : WU-80 (配件編號) PART NAME : Windproof W-angle 配件名稱 : 特製防風W角

UL-SERIES (垂直條型掛式天花系列)

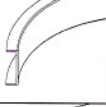
	PART CODE : UL-101 (配件編號) PART NAME : UL Bracket 配件名稱 : UL吊碼
	PART CODE : UL-102 (配件編號) PART NAME : Positioned Carrier 配件名稱 : 定位C型龍骨
	PART CODE : UL-103 (配件編號) PART NAME : Carrier Bracket 配件名稱 : 定位龍骨吊碼
	PART CODE : UL-104 (配件編號) PART NAME : End Cap 配件名稱 : 封口蓋
	PART CODE : UL-105 (配件編號) PART NAME : Panel Connector 配件名稱 : 天花片駁碼
	PART CODE : UL-106 (配件編號) PART NAME : Carrier Wall Bracket 配件名稱 : 定位龍骨牆身碼

	PART CODE : WU-80A (配件編號) PART NAME : Windproof W-angle 配件名稱 : 特製防風W角配件
	PART CODE : LRI-40/LRO-50 (配件編號) PART NAME : Outside curved L-angle 配件名稱 : 外弧L角
	PART CODE : LRI-40/LRI-50 (配件編號) PART NAME : Inside curved L-angle 配件名稱 : 內弧L角
	PART CODE : WRO-80 (配件編號) PART NAME : Outside curved W-angle 配件名稱 : 外弧W角
	PART CODE : WRI-80 (配件編號) PART NAME : Inside curved L-angle 配件名稱 : 內弧L角
	PART CODE : CRO-62 (配件編號) PART NAME : Outside curved C-Channel 配件名稱 : 外弧C槽
	PART CODE : CRI-62 (配件編號) PART NAME : Inside curved C-Channel 配件名稱 : 內弧C槽